

调心滚子轴承

H31 HE31 HA31- H3120

参数信息:

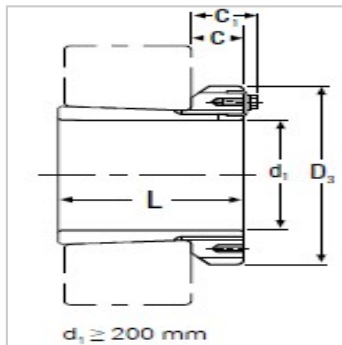
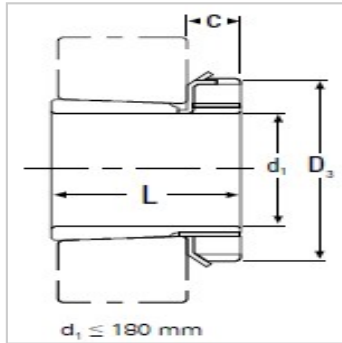

型号 :	H3120
d1 :	
Hmm :	90
HEin. :	3 1/2
HAin. :	3 7/16
Lmm :	76
Dmm :	130
Cmm :	20
Cmm :	-
锁紧螺母 :	KM20
锁紧垫圈 :	MB20
重量kg :	1.800

: